

OKI Semiconductor

MK32VT1664A-8YC

16,777,216 Word x 64 Bit SYNCHRONOUS DYNAMIC RAM MODULE (2BANK):

DESCRIPTION

The Oki MK32VT1664A-8YC is a fully decoded, 16,777,216 x 64bit synchronous dynamic random access memory composed of sixteen 64Mb DRAMs (8Mx8) in TSOP packages mounted with decoupling capacitors on a 168-pin glass epoxy Dual-in-Line Package supports any application where high density and large capacity of storage memory are required, like for example PCs or servers.

FEATURES

- 16-Meg Word x 64-bit (2Bank 8Byte) organization
- 168-pin Dual Inline Memory Module
- All DQ Pins have 10 Ω Damping Resister
- Single 3.3V power supply, $\pm 0.3V$ tolerance
- Input :LVTTL compatible
- Output :LVTTL compatible
- Refresh : 4,096 cycles/64 ms
- Programmable data transfer mode
 - /CAS latency (2, 3)
 - Burst length (1, 2, 4, 8, Full)
 - Data scramble (sequential, interleave)
- /CAS before /RAS auto-refresh, Self-refresh capability
- Serial Presence Detect (SPD) With EEPROM

PRODUCT ORGANIZATION

Product Name	Operation Frequency (Max.)	Access Time (Max.)	
		t _{AC2}	t _{AC3}
MK32VT1664A-8YC	125 MHz	10.0ns	6.0ns

Note. Specification are subject to change without notice.

BLOCK DIAGRAM

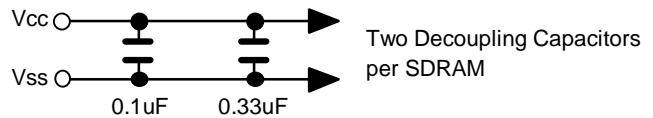
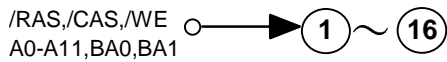
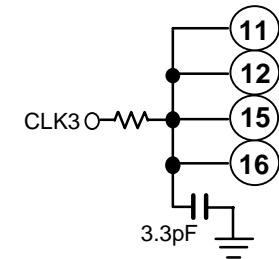
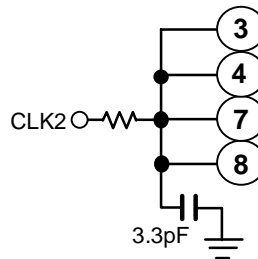
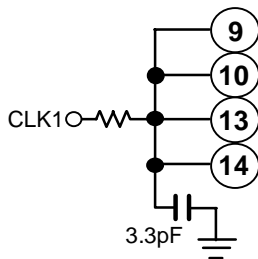
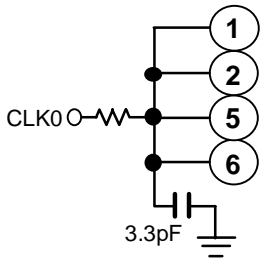
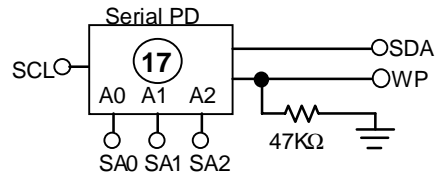
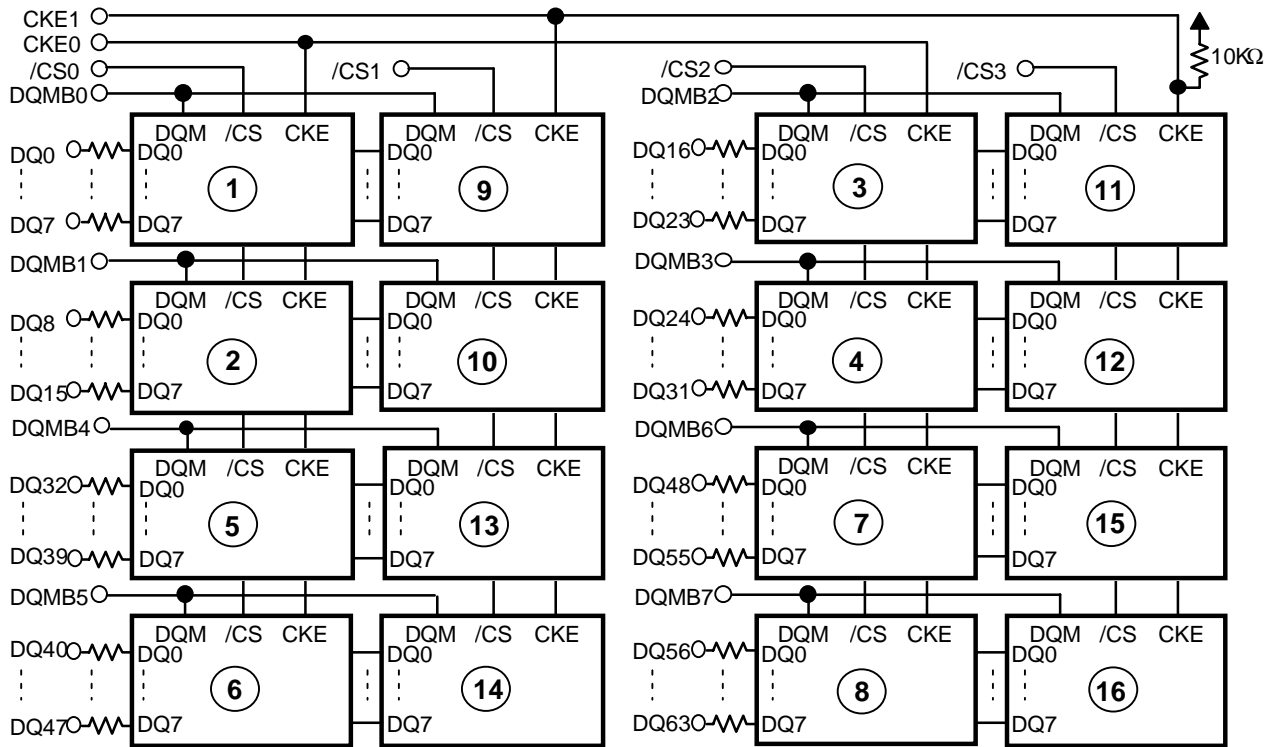

Note. The Value of all resistors is 10Ω expect WP and CKE1

MODULE OUTLINE

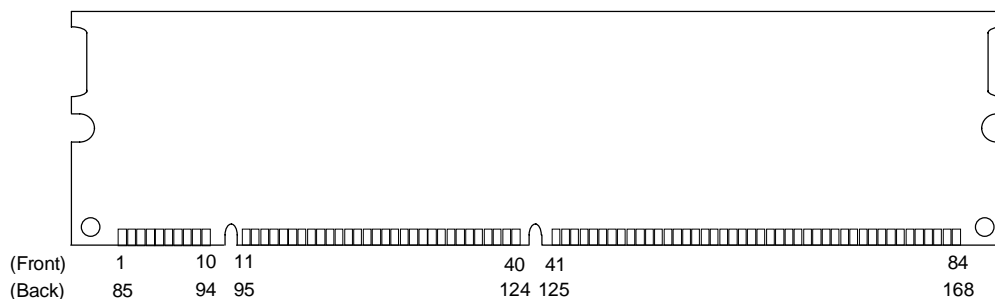

PIN CONFIGURATION

Front		Back side	
Pin No.	Pin name	Pin No.	Pin name
1	Vss	85	Vss
2	DQ0	86	DQ32
3	DQ1	87	DQ33
4	DQ2	88	DQ34
5	DQ3	89	DQ35
6	Vcc	90	Vcc
7	DQ4	91	DQ36
8	DQ5	92	DQ37
9	DQ6	93	DQ38
10	DQ7	94	DQ39
11	DQ8	95	DQ40
12	Vss	96	Vss
13	DQ9	97	DQ41
14	DQ10	98	DQ42
15	DQ11	99	DQ43
16	DQ12	100	DQ44
17	DQ13	101	DQ45
18	Vcc	102	Vcc
19	DQ14	103	DQ46
20	DQ15	104	DQ47
21	N.C	105	N.C
22	N.C	106	N.C
23	Vss	107	Vss
24	N.C	108	N.C
25	N.C	109	N.C
26	Vcc	110	Vcc
27	/WE	111	/CAS
28	DQMB0	112	DQMB4
29	DQMB1	113	DQMB5
30	/CS0	114	/CS1
31	N.C	115	/RAS
32	Vss	116	Vss
33	A0	117	A1
34	A2	118	A3
35	A4	119	A5
36	A6	120	A7
37	A8	121	A9
38	A10	122	BA0
39	BA1	123	A11
40	Vcc	124	Vcc
41	Vcc	125	CLK1
42	CLK0	126	N.C

Front side		Back side	
Pin No.	Pin name	Pin No.	Pin name
43	Vss	127	Vss
44	N.C	128	CKE0
45	/CS2	129	/CS3
46	DQMB2	130	DQMB6
47	DQMB3	131	DQMB7
48	N.C	132	N.C
49	Vcc	133	Vcc
50	N.C	134	N.C
51	N.C	135	N.C
52	N.C	136	N.C
53	N.C	137	N.C
54	Vss	138	Vss
55	DQ16	139	DQ48
56	DQ17	140	DQ49
57	DQ18	141	DQ50
58	DQ19	142	DQ51
59	Vcc	143	Vcc
60	DQ20	144	DQ52
61	N.C	145	N.C
62	N.C	146	N.C
63	CKE1	147	N.C
64	Vss	148	Vss
65	DQ21	149	DQ53
66	DQ22	150	DQ54
67	DQ23	151	DQ55
68	Vss	152	Vss
69	DQ24	153	DQ56
70	DQ25	154	DQ57
71	DQ26	155	DQ58
72	DQ27	156	DQ59
73	Vcc	157	Vcc
74	DQ28	158	DQ60
75	DQ29	159	DQ61
76	DQ30	160	DQ62
77	DQ31	161	DQ63
78	Vss	162	Vss
79	CLK2	163	CLK3
80	N.C	164	N.C
81	WP	165	SA0
82	SDA	166	SA1
83	SCL	167	SA2
84	Vcc	168	Vcc

Pin Name	Function	Pin Name	Function
Vcc	Power Supply (3.3V)	/WE	Write Enable
Vss	Ground (0V)	DQMB#	Data Input/Output Mask
CLK#	System Clock	DQ#	Data Input/Output
/CS#	Chip Select	WP	Write Protect
CKE#	Clock Enable	SDA	Data I/O for SPD
A0-A11	Address	SCL	CLK input for SPD
BA0,BA1	Bank Select Address	SA#	Socket Position Address for SPD
/RAS	Row Address Strobe	N.C	No Connection
/CAS	Column Address Strobe		

SERIAL PRESENCE DETECT

Byte No.	SPD Hex Value	Remark	Notes
0	80	Defines the number of bytes written into SPD memory	128 byte
1	08	Total number of bytes of SPD memory	256 byte
2	04	Fundamental memory type	SDRAM
3	0C	Number of rows	12 rows
4	09	Number of columns	9 columns
5	02	Number of module banks	2 bank
6	40	Data width of this assembly	64 bits
7	00	... Data width continuation	0
8	01	Voltage interface level	LVTTL
9	80	Cycle time (CL=3)	CL=3 tCC=8ns
10	60	Access time from CLK (CL=3)	CL=3 tAC3=6ns
11	00	DIMM configuration type	None Parity
12	80	Refresh rate / type	Normal / Self
13	08	Primary SDRAM width	x8
14	00	Error checking SDRAM width	
15	01	Minimum CLK delay	tCCD: 1 CLK
16	8F	Burst lengths supported	1, 2, 4, 8, F
17	04	Number of banks on each SDRAM	4 banks
18	06	/CAS latency	2, 3
19	01	/CS latency	0
20	01	/WE latency	0
21	00	SDRAM module attributes	
22	0E	SDRAM device attributes : General	
23	C0	Cycle time (CL=2)	CL=2 tCC2=12ns
24	A0	Access time from CLK (CL=2)	CL=2 tAC2=10ns
25	00	Cycle time (CL=1)	Not support
26	00	Access time from CLK (CL=1)	Not support
27	1E	Minimum ROW pulse width	tRP=30ns
28	10	/RAS to /RAS bank delay	tRRD=16ns
29	14	/RAS to /CAS delay	tRCD=20ns
30	30	Minimum /RAS precharge time	tRAS=48ns
31	10	Density of each bank on module	64MB
32	20	Command and address signal input setup time	2ns
33	10	Command and address signal input hold time	1ns
34	20	Data signal input setup time	2ns
35	10	Data signal input hold time	1ns
36-61	00-00		R.F.U
62	12	SPD data revision code	1.2
63	4A	Checksum for byte 0-62	
64-71	41, 45, 20, 20, 20, 20, 20, 20	Manufacturer's JEDEC ID code	
72	01/06	Manufacturing location	
73-90	4D, 4B, 33, 32, 56, 54, 31, 36, 36, 34, 41, 2D, 38, 59, 43, 20, 20, 20	Manufacturer's part number	MK32VT1664A-8YC
91,92	20,20	Revision code	
93-125	00-00	R.F.U	
126	64	Intel specification frequency	100MHz
127	F5	Intel specification /CAS latency	CLK0-3, CL=3
128-255	FF-FF	Unused storage locations	

ELECTRICAL CHARACTERISTICS

Absolute Maximum Ratings

Rating	Symbol	Value	Unit
Voltage on any pin relative to Vss	V _{IN} , V _{OUT}	-0.5 to V _{CC} +0.5	V
Vcc supply voltage	V _{CC} , V _{CCQ}	-0.5 to 4.6	V
Storage temperature	T _{stg}	- 55 to 125	°C
Power dissipation	P _D *	16	W
Short circuit current	I _{OS}	50	mA
Operating temperature	T _{opr}	0 to 70	°C

*: Ta=25°C

Recommended Operating Conditions

(Voltages referenced to Vss = 0V)

Parameter	Symbol	Min.	Typ.	Max.	Unit
Power supply voltage	V _{CC} , V _{CCQ}	3.0	3.3	3.6	V
Input high voltage	V _{IH}	2.0	-	V _{CC} +0.3	V
Input low voltage	V _{IL}	-0.3	-	0.8	V

Capacitance

(V_{CC} = 3.3V ± 0.3V, Ta = 25°C f = 1MHz)

Parameter	Symbol	Max.	Unit
Input capacitance(A0-A11,BA0,BA1,/RAS, /CAS,/WE)	C _{IN1}	98	pF
Input capacitance(/CS0,/CS1,/CS2,/CS3)	C _{IN2}	34	pF
Input capacitance(DQMB0-DQMB7)	C _{IN3}	22	pF
Input capacitance(CKE0,CKE1)	C _{IN4}	58	pF
I/O capacitance(DQ0-DQ63)	C _{I/O}	25	pF
Input capacitance(CLK0,CLK1,CLK2,CLK3)	C _{CLK}	50	pF

DC CHARACTERISTICS

(V_{CC} = 3.3V ± 0.3V, T_a = 0 to 70°C)

Parameter	Symbol	Condition		Module Spec.		Unit	Note
		CKE	Others	Min.	Max.		
Output High Voltage	V _{OH}	-	I _{OH} = -2.0mA	2.4	-	V	
Output Low Voltage	V _{OL}	-	I _{OL} = 2.0mA	-	0.4	V	
Input Leakage Current	I _{LI}	-	-	-80	80	uA	
Output Leakage Current	I _{LO}	-	-	-10	10	uA	
Average Power Supply Current (Operating)	I _{CC1}	CKE ≥ V _{IH}	t _{CC} =min. t _{RC} =min. No Burst	-	1240	mA	1, 2
Power Supply Current (Stand by)	I _{CC2}	CKE ≥ V _{IH}	t _{CC} =min.	-	480	mA	3
Average Power Supply Current (Clock Suspension)	I _{CC3S}	CKE ≤ V _{IL}	t _{CC} =min.	-	96	mA	2
Average Power Supply Current (Active Stand by)	I _{CC3}	CKE ≥ V _{IH} , /CS ≥ V _{IH}	t _{CC} =min.	-	720	mA	3
Power Supply Current (Burst)	I _{CC4}	CKE ≥ V _{IH}	t _{CC} =min.	-	1560	mA	1, 2
Power Supply Current (Auto-Refresh)	I _{CC5}	CKE ≥ V _{IH}	t _{CC} =min. t _{RC} =min.	-	1720	mA	2
Average Power Supply Current (Self-Refresh)	I _{CC6}	CKE ≤ 0.2V	t _{CC} =min.	-	16	mA	
Average Power Supply Current (Power down)	I _{CC7}	CKE ≤ V _{IL}	t _{CC} =min.	-	32	mA	

- Notes: 1. Measured with the output open.
 2. Address and data can be changed once or not be changed during one cycle.
 3. Address and data can be changed once or not be changed during two cycle.

MODE SET ADDRESS KEYS

Write Burst		/CAS Latency				Burst Type		Burst Length				
A9	Write Burst	A6	A5	A4	CL	A3	BT	A2	A1	A0	BT=0	BT=1
0	Burst Write	0	0	0	Reserved	0	Sequential	0	0	0	Reserved	Reserved
1	Single bit Write	0	0	1	Reserved	1	Interleave	0	0	1	2	2
		0	1	0	2			0	1	0	4	4
		0	1	1	3			0	1	1	8	8
		1	0	0	Reserved			1	0	0	Reserved	Reserved
		1	0	1	Reserved			1	0	1	Reserved	Reserved
		1	1	0	Reserved			1	1	0	Reserved	Reserved
		1	1	1	Reserved			1	1	1	Full page	Reserved

Note: A7,A8, A10,A11,BA0,BA1 and All should stay "L" during mode set cycle.

POWER ON SEQUENCE

1. With inputs in NOP state, turn on the power supply and enter the system clock.
2. After the Vcc voltage has reached the specified level, take a pause of 200us or more with the input being NOP.
3. Enter the precharge all bank command.
4. Apply CBR auto-refresh eight or more times.
5. Enter the mode register setting command.

AC CHARACTERISTIC

(V_{CC} = 3.3V ± 0.3V, T_a = 0 ~ 70°C)

NOTE 1, 2

Parameter	Symbol	Module Spec.		Unit	Note	
		Min.	Max.			
Clock Cycle Time	CL=3	t _{CC}	8	-	ns	
	CL=2		12	-	ns	
Access Time from Clock	CL=3	t _{AC}	-	6	ns	3, 4
			-	10	ns	3, 4
Clock "H" Pulse Time		t _{CH}	3	-	ns	
Clock "L" Pulse Time		t _{CL}	3	-	ns	
Input Setup Time		t _{SI}	2	-	ns	
Input Hold Time		t _{HI}	1	-	ns	
Output Low Impedance Time from Clock		t _{OLZ}	3	-	ns	
Output High Impedance Time from Clock		t _{OHZ}	-	8	ns	
Output Hold from Clock		t _{OH}	3	-	ns	3
/RAS Cycle Time		t _{RC}	80	-	ns	
/RAS Precharge Time		t _{RP}	30	-	ns	
/RAS Active Time		t _{RAS}	48	100,000	ns	
/RAS to /CAS Delay Time		t _{RCD}	20	-	ns	
Write Recovery Time		t _{WR}	8	-	ns	
/RAS to /RAS Bank Active Delay Time		t _{RRD}	16	-	ns	
Refresh Time		t _{REF}	-	64	ms	
Power-down Exit Set-up Time		t _{PDE}	t _{SI} +1CLK	-	ns	
Input Level Transition Time		t _T	-	3	ns	
/CAS to /CAS Delay Time (Min)		t _{CCD}	1		Cycle	
Clock Disable Time from CKE		t _{CKE}	1		Cycle	
Data Output High Impedance Time from DQMB		t _{DOZ}	2		Cycle	
Data Input Mask Time from DQMB		t _{DOD}	0		Cycle	
Data Input Time from Write Command		t _{DWD}	0		Cycle	
Data Output High Impedance Time from Precharge Command	CL=3	t _{IROH}	3		Cycle	
	CL=2		2		Cycle	
Active Command Input Time from MODE Register Set Command Input (Min)		t _{MRD}	2		Cycle	
Write Command Input Time from Output		t _{OWD}	2		Cycle	

NOTES:

- 1) AC measurements assume t_T=1ns.
- 2) The reference level for timing of input signals is 1.4V.
- 3) This parameter is measured with a load circuit equivalent to 1 TTL load and 50pF (R_{Load} is 50ohm).
- 4) An access time is measured at 1.4V.
- 5) If t_T is longer than 1ns, the reference level for timing of input signals are V_{IH} and V_{IL}.

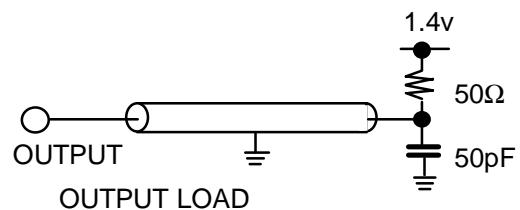

FUNCTION TRUTH TABLE (Table1)(1/2)

Current State	/CS	/RAS	/CAS	/WE	BA	ADDR	Action
Idle	H	X	X	X	X	X	NOP
	L	H	H	H	X	X	NOP
	L	H	H	L	BA	X	ILLEGAL ²
	L	H	L	X	BA	CA	ILLEGAL ²
	L	L	H	H	BA	RA	Row Active
	L	L	H	L	BA	A10	NOP ⁴
	L	L	L	H	X	X	Auto-Refresh or Self-Refresh ⁵
Row Active	L	L	L	L	L	OP Code	Mode Register write
	H	X	X	X	X	X	NOP
	L	H	H	X	X	X	NOP
	L	H	L	H	BA	CA, A10	Read
	L	H	L	L	BA	CA, A10	Write
	L	L	H	H	BA	RA	ILLEGAL ²
	L	L	H	L	BA	A10	Precharge
Read	L	L	L	X	X	X	ILLEGAL
	H	X	X	X	X	X	NOP(Continue Row Active after Burst ends)
	L	H	H	H	X	X	NOP(Continue Row Active after Burst ends)
	L	H	H	L	BA	X	Burst Stop
	L	H	L	H	BA	CA, A10	Term Burst,start new Burst Read ³
	L	H	L	L	BA	CA, A10	Term Burst,start new Burst Write ³
	L	L	H	H	BA	RA	ILLEGAL ²
Write	L	L	H	L	BA	A10	Term Burst,execute Row Precharge
	L	L	L	X	X	X	ILLEGAL
	H	X	X	X	X	X	NOP(Continue Row Active after Burst ends)
	L	H	H	H	X	X	NOP(Continue Row Active after Burst ends)
	L	H	H	L	BA	X	Burst Stop
	L	H	L	H	BA	CA, A10	Term Burst,start new Burst Read ³
	L	H	L	L	BA	CA, A10	Term Burst,start new Burst Write ³
Read with Auto Precharge	L	L	H	H	BA	RA	ILLEGAL ²
	L	L	H	L	BA	A10	Term Burst,execute Row Precharge ³
	L	L	L	X	X	X	ILLEGAL
	H	X	X	X	X	X	NOP(Continue Burst to End and enter Row Precharge)
	L	H	H	H	X	X	NOP(Continue Burst to End and enter Row Precharge)
	L	H	H	L	BA	X	ILLEGAL ²
	L	H	L	H	BA	CA, A10	ILLEGAL ²
Write with Auto Precharge	L	H	L	L	X	X	ILLEGAL
	L	L	H	X	BA	RA, A10	ILLEGAL ²
	L	L	L	X	X	X	ILLEGAL
	L	H	H	H	X	X	NOP(Continue Burst to End and enter Row Precharge)
	L	H	H	L	BA	X	ILLEGAL ²
	L	H	L	H	BA	CA, A10	ILLEGAL ²
	L	H	L	L	X	X	ILLEGAL
Write with Auto Precharge	L	L	H	X	BA	RA, A10	ILLEGAL ²
	L	L	L	X	X	X	ILLEGAL
	L	L	L	X	X	X	ILLEGAL
	L	L	L	X	X	X	ILLEGAL
	L	L	L	X	X	X	ILLEGAL
	L	L	L	X	X	X	ILLEGAL

FUNCTION TRUTH TABLE (Table1)(2/2)

Current State	/CS	/RAS	/CAS	/WE	BA	ADDR	Action
Precharge	H	X	X	X	X	X	NOP → Idle after tRP
	L	H	H	H	X	X	NOP → Idle after tRP
	L	H	H	L	BA	X	ILLEGAL ²
	L	H	L	X	BA	CA	ILLEGAL ²
	L	L	H	H	BA	RA	ILLEGAL ²
	L	L	H	L	BA	A10	NOP ⁴
	L	L	L	X	X	X	ILLEGAL
Write Recovery	H	X	X	X	X	X	NOP
	L	H	H	H	X	X	NOP
	L	H	H	L	BA	X	ILLEGAL ²
	L	H	L	X	BA	CA	ILLEGAL ²
	L	L	H	H	BA	RA	ILLEGAL ²
	L	L	H	L	BA	A10	ILLEGAL ²
	L	L	L	X	X	X	ILLEGAL
Row Active	H	X	X	X	X	X	NOP Row Active after tRCD
	L	H	H	H	X	X	NOP Row Active after tRCD
	L	H	H	L	BA	X	ILLEGAL ²
	L	H	L	X	BA	CA	ILLEGAL ²
	L	L	H	H	BA	RA	ILLEGAL ²
	L	L	H	L	BA	A10	ILLEGAL ²
	L	L	L	X	X	X	ILLEGAL
Refresh	H	X	X	X	X	X	NOP → Idle after tRC
	L	H	H	X	X	X	NOP → Idle after tRC
	L	H	L	X	X	X	ILLEGAL
	L	L	H	X	X	X	ILLEGAL
	L	L	L	X	X	X	ILLEGAL
Auto Resister Access	H	X	X	X	X	X	NOP
	L	H	H	H	X	X	NOP
	L	H	H	L	X	X	ILLEGAL
	L	H	L	X	X	X	ILLEGAL
	L	L	X	X	X	X	ILLEGAL

ABBREVIATIONS

RA = Row Address

BA = Bank Address

NOP = No Operation command

CA = Column Address

AP = Auto Precharge

Notes:

- All inputs will be enabled when CKE is set high for at least 1 cycle prior to the inputs.
- Illegal to bank in specified state, but may be legal in some cases depending on the state of bank selection.
- Satisfy the timing of tCCD and tWR to prevent bus contention.
- NOP to bank precharging or in idle state. Precharges activated bank by BA or A10.
- Illegal if any bank is not idle.

FUNCTION TRUTH TABLE (CKE) (Table2)

Current State(n)	CKEn-1	CKEn	/CS	/RAS	/CAS	/WE	ADDR	Action
Self Refresh	H	X	X	X	X	X	X	INVALID
	L	H	H	X	X	X	X	Exit Self Refresh → ABI
	L	H	L	H	H	H	X	Exit Self Refresh → ABI
	L	H	L	H	H	L	X	ILLEGAL
	L	H	L	H	L	X	X	ILLEGAL
	L	H	L	L	X	X	X	ILLEGAL
	L	L	X	X	X	X	X	NOP(Maintain Self Refresh)
Power Down	H	X	X	X	X	X	X	INVALID
	L	H	H	X	X	X	X	Exit Power Down → ABI
	L	H	L	H	H	H	X	Exit Power Down → ABI
	L	H	L	H	H	L	X	ILLEGAL
	L	H	L	H	L	X	X	ILLEGAL
	L	H	L	X	X	X	X	ILLEGAL ⁶
	L	L	X	X	X	X	X	NOP(Continue power down mode)
All Banks idle ⁶ (ABI)	H	H	X	X	X	X	X	Refer to Table 1
	H	L	H	X	X	X	X	Enter Power Down
	H	L	L	H	H	H	X	Enter Power Down
	H	L	L	H	H	L	X	ILLEGAL
	H	L	L	H	L	X	X	ILLEGAL
	H	L	L	L	H	L	X	ILLEGAL
	H	L	L	L	L	H	X	Enter Self Refresh
	L	L	L	L	L	L	X	ILLEGAL
Any State Other than Listed Above	L	L	X	X	X	X	X	NOP
	H	H	X	X	X	X	X	Refer to Operations in Table 1
	H	L	X	X	X	X	X	Begin Clock Suspend Next Cycle
	L	H	X	X	X	X	X	Enable Clock of Next Cycle
	L	L	X	X	X	X	X	Continue Clock Suspension

Notes:

6. Power-down and self refresh can be entered only when all the banks are in an idle state.