

OKI electronic components

T36CP2, T36CP3, T54LCP, OPU860CP, OPU862CP

Photo capsule

GENERAL DESCRIPTION

The T36CP2/T36CP3/T54LCP/OPU860CP/OPU862 are sensors that are most suited to paper detection. For superior dustproof packaging and easy mounting, a phototransistor can be sealed (encapsulated) into a package with connectors.

The OPU862CP can be mounted with a space (200mm) between the device and the LED capsule because the device has a non-spherical surface lens.

The OPU860CP and OPU862CP assure a high quality because they have been assembled without soldering or using adhesive.

FEATURES

- The light axis is positioned for efficient insertion into LED capsules and photosensors.
- The sensor unit element is protected from dust.
- The assembly and mount are easy (without soldering).

APPLICATIONS

- Banking terminals (ATM, etc.)
- Printers
- Copying machines
- Communications terminals (FAX, etc.)

PIN CONFIGURATION

- T36CP2, T36CP3

(Unit: mm)

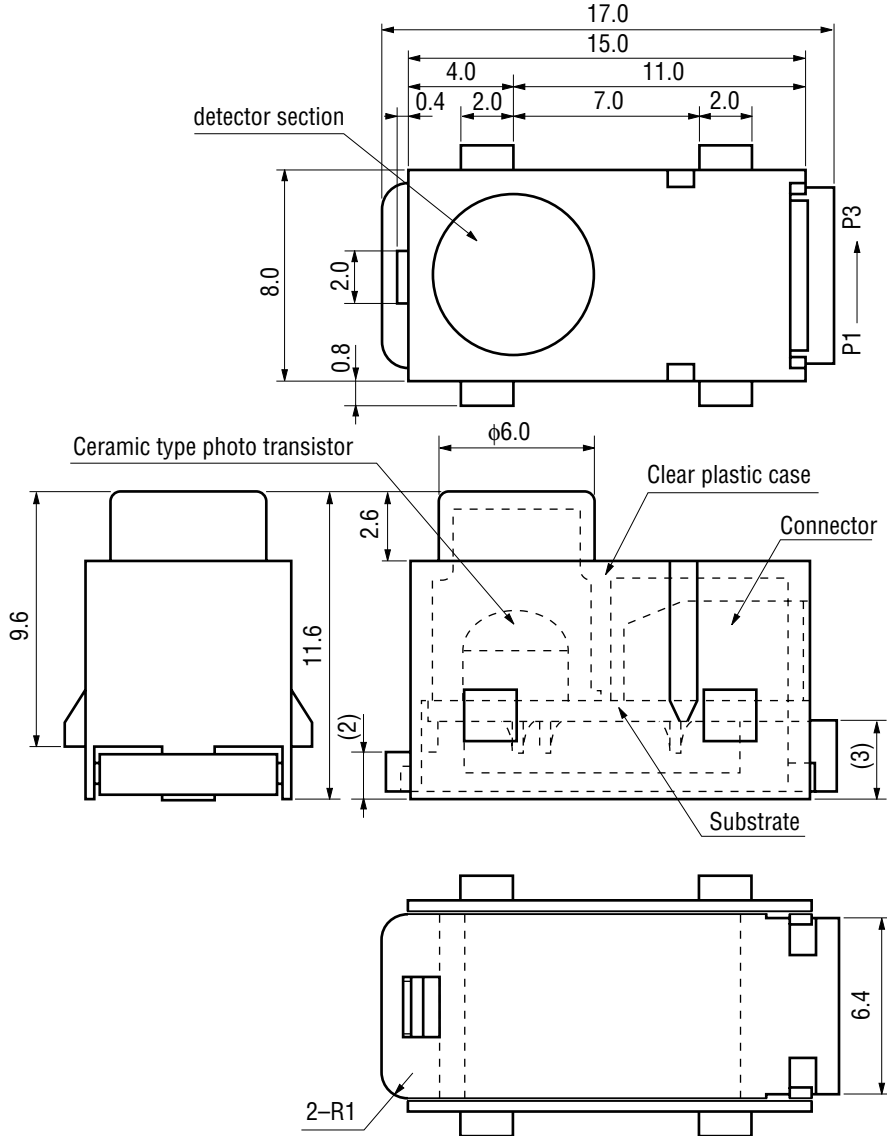

- Pin Connection Diagram
(P No. indicates the pin number of connectors.)

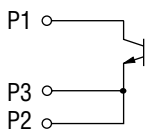

P2, P3: Emitter
P1 : Collector

• T54LCP

(Unit: mm)

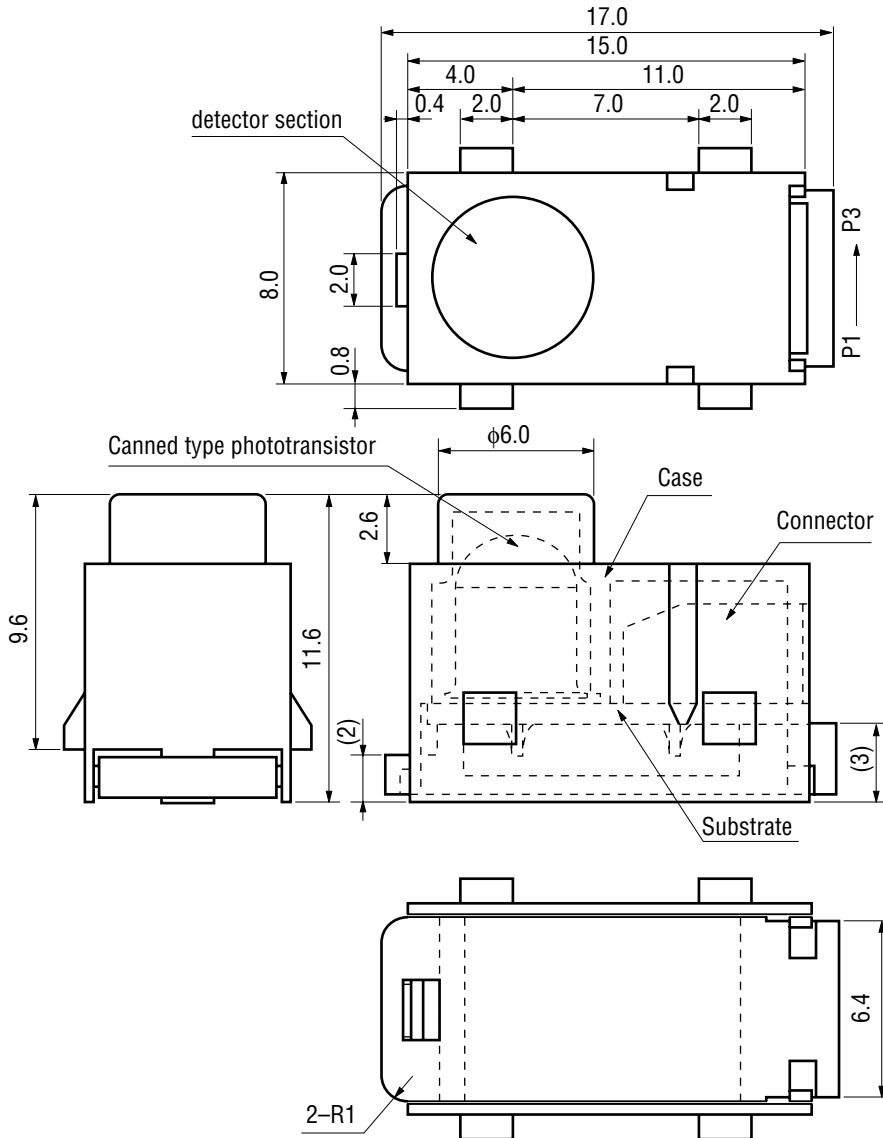

- Pin Connection Diagram
(P No. indicates the pin number of connectors.)

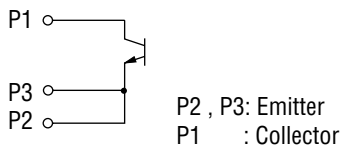

• OPU860CP, OPU862CP

(Unit: mm)

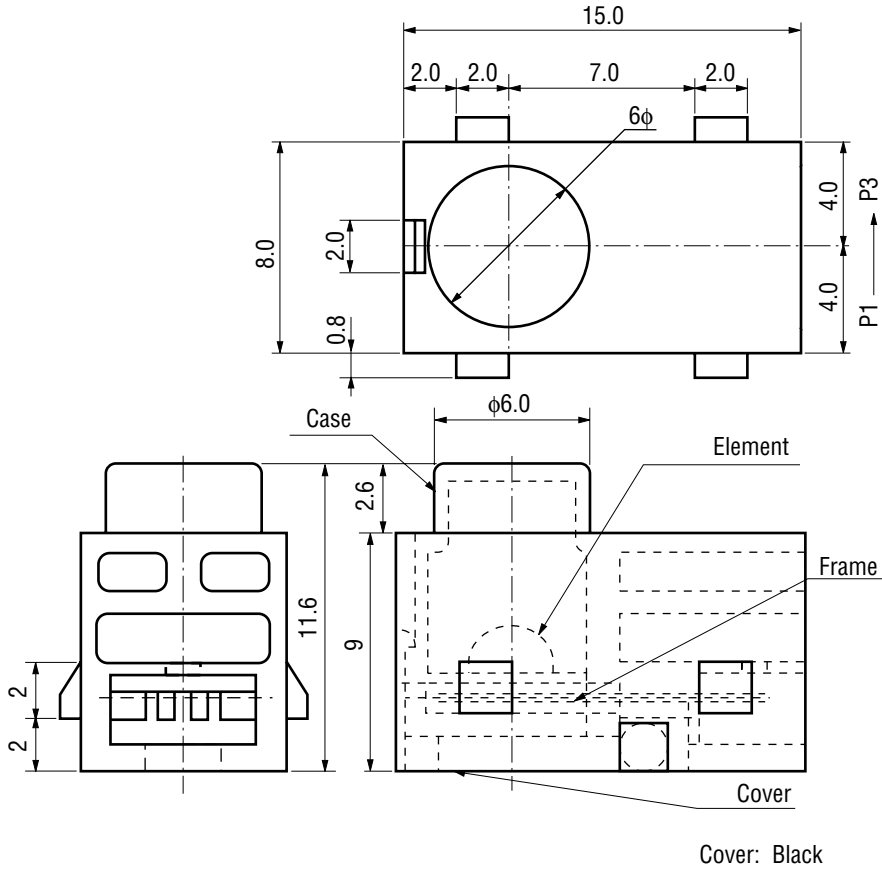

- Pin Connection Diagram
(P No. indicates the pin number of connectors.)

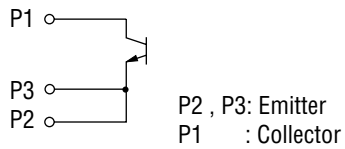

ABSOLUTE MAXIMUM RATINGS

Parameter	Symbol	Test Condition	Rating		Unit
			T36CP2, 3	T54LCP	
Temperature Storage	T_{stg}	—	-20 to +80		°C
Operating Temperature	T_{opr}	—	-10 to +60		°C
Emitter-Collector Voltage	V_{ECO}	$T_a=25^{\circ}\text{C}$	5		V
Collector-Emitter Voltage	V_{CEO}		20		V
Collector Current	I_C		10	30	mA
Power Dissipation	P_C		150		mW

Parameter	Symbol	Test Condition	Rating		Unit
			OPU860CP	OPU862CP	
Temperature Storage	T_{stg}	—	-10 to +60		°C
Operating Temperature	T_{opr}	—	-10 to +60		°C
Emitter-Collector Voltage	V_{ECO}	$T_a=25^{\circ}\text{C}$	5		V
Collector-Emitter Voltage	V_{CEO}		20		V
Collector Current	I_C		10	30	mA
Power Dissipation	P_C		150		mW

ELECTRICAL CHARACTERISTICS

• T36CP2, T36CP3

(Ambient Temperature $T_a=25^{\circ}\text{C}$)

Parameter	Symbol	Condition	Min.	Typ.	Max.	Unit
Dark Current	I_D	$V_{CE}=9\text{ V}$	—	—	100	nA
Collector-Emitter breakdown Voltage	BV_{CEO}	$I_C=100\ \mu\text{A}$	20	—	—	V
Output Photocurrent ***	I_{P1}^{**}	$I_F=50\text{ mA}$	0.9	—	4.1	mA
		$V_{CE}=1\text{ V}$ $L^*=10\text{ mm}$	1.85	—	6.1	
	I_{P2}^{**}	$I_F=50\text{ mA}$	40	—	200	μA
		$V_{CE}=1\text{ V}$ $L^*=100\text{ mm}$	75	—	300	

* : Distance between sensors.

** : The specifications for T36CP2 are shown in the upper and for T36CP3 in the lower.

*** : Measuring circuit.

CAPSULE SENSOR**T36CP2, T36CP3, T54LCP, OPU860CP, OPU862CP**• **T54LCP**(Ambient Temperature $T_a=25^{\circ}\text{C}$)

Parameter	Symbol	Condition	Min.	Typ.	Max.	Unit
Dark Current	I_D	$V_{CE}=10\text{ V}$	—	—	100	nA
Collector-Emitter Breakdown Voltage	BV_{CEO}	$I_C=500\ \mu\text{A}$	20	—	—	V
Output Photocurrent **	I_{P1}	$I_F=50\text{ mA}$ $V_{CE}=1\text{ V}$ $L^*=50\text{ mm}$	5.2	—	28	mA
	I_{P2}	$I_F=50\text{ mA}$ $V_{CE}=1\text{ V}$ $L^*=200\text{ mm}$	0.4	—	2.8	mA

* : Distance between sensors

** : Measuring circuit

• **OPU860CP**(Ambient Temperature $T_a=25^{\circ}\text{C}$)

Parameter	Symbol	Condition	Min.	Typ.	Max.	Unit
Dark Current	I_D	$V_{CE}=9\text{ V}$	—	—	100	nA
Collector-Emitter Breakdown Voltage	BV_{CEO}	$I_C=100\ \mu\text{A}$	20	—	—	V
Output Photocurrent **	I_{P1}	$I_F=50\text{ mA}$ $V_{CE}=1\text{ V}$ $L^*=10\text{ mm}$	3	—	20	mA
	I_{P2}	$I_F=50\text{ mA}$ $V_{CE}=1\text{ V}$ $L^*=100\text{ mm}$	0.1	—	1.5	mA

* : Distance between sensors

** : Measuring circuit

CAPSULE SENSOR

T36CP2, T36CP3, T54LCP, OPU860CP, OPU862CP

• **OP862CP**

(Ambient Temperature $T_a=25^{\circ}\text{C}$)

Parameter	Symbol	Condition	Min.	Typ.	Max.	Unit
Dark Current	I_D	$V_{CE}=10\text{ V}$	—	—	100	nA
Collector-Emitter Breakdown Voltage	BV_{CEO}	$I_C=500\ \mu\text{A}$	20	—	—	V
Output Photocurrent **	I_{P1}	$I_F=50\text{ mA}$ $V_{CE}=1\text{ V}$ $L^*=50\text{ mm}$	5.2	—	28	mA
	I_{P2}	$I_F=50\text{ mA}$ $V_{CE}=1\text{ V}$ $L^*=200\text{ mm}$	0.4	—	5.0	mA

* : Distance between sensors

** : Measuring circuit

Measuring circuit

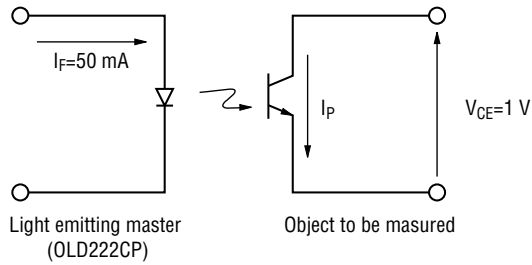

TYPICAL CHARACTERISTICS

- T36CP2, OPU860CP Spectral Sensitivity

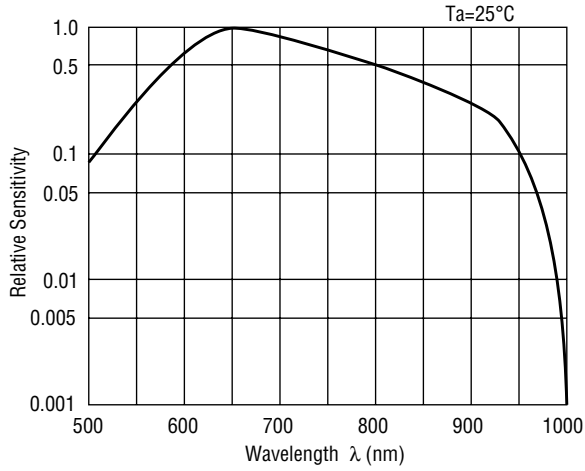

- T54LCP, OPU862CP Spectral Sensitivity

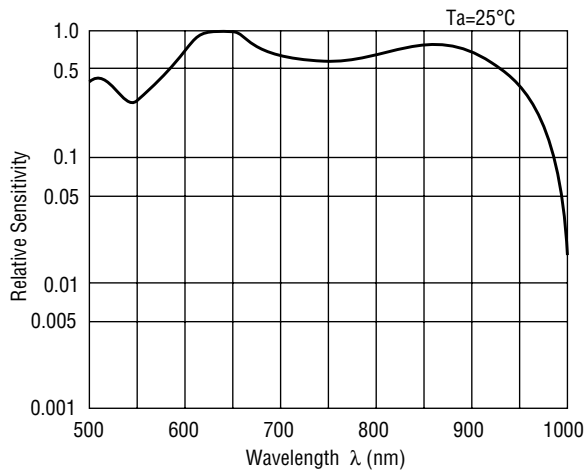

• OPU860CP Directional Characteristic

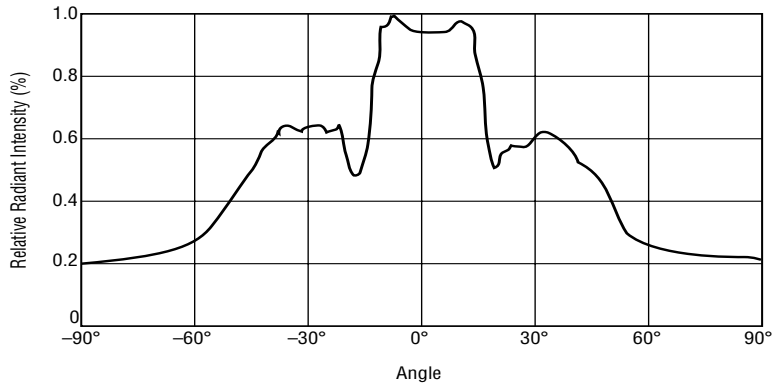

• OPU862CP Directional Characteristic

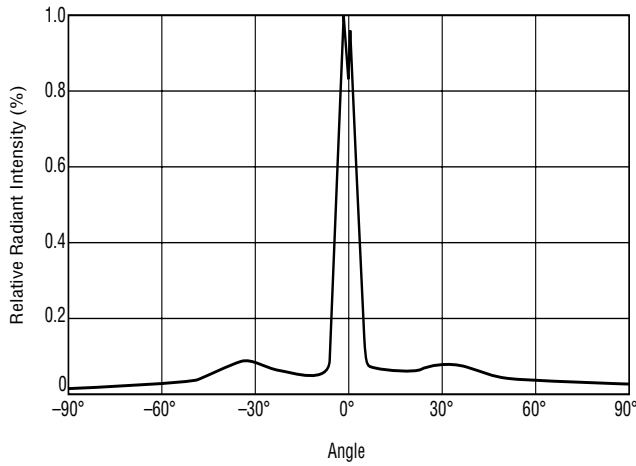

• T36CP2—OLD122CP3 Switching Time vs. Load Resistance

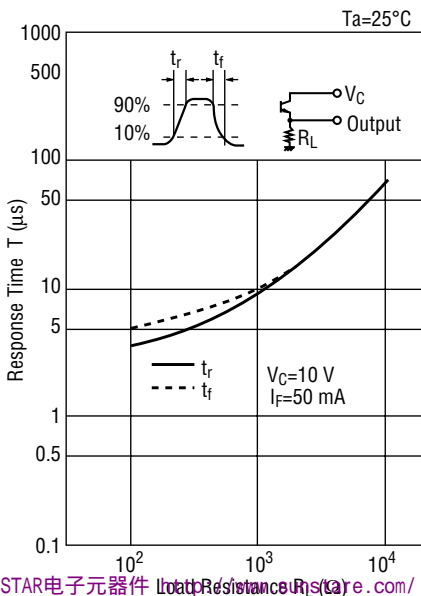

• T36CP2—OLD222CP Switching Time vs. Load Resistance

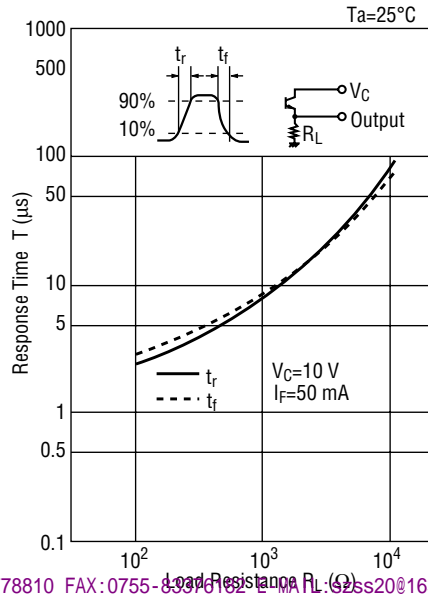

• T54LCP—OLD122CP3 Switching Time vs. Load Resistance

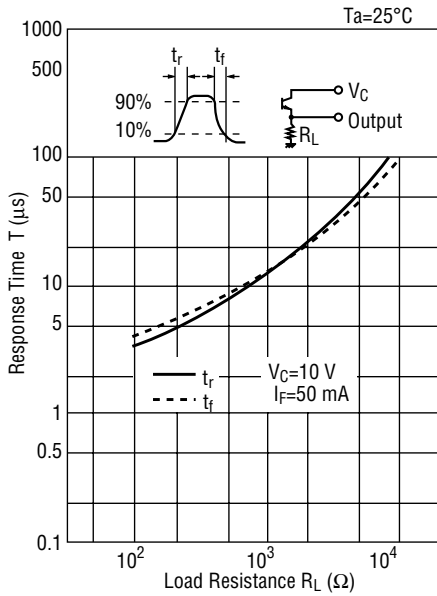

• T54LCP—OLD222CP Switching Time vs. Load Resistance

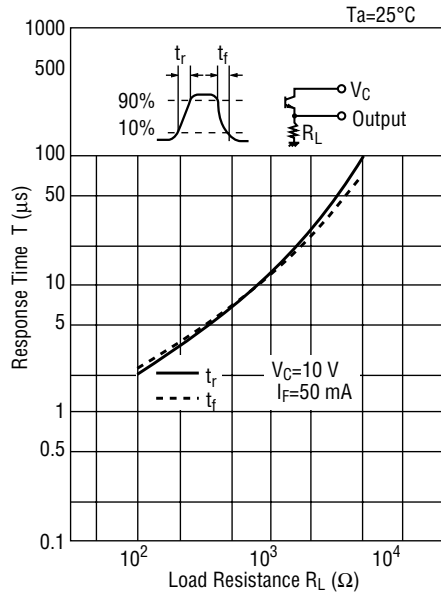

• OPU860CP—OPU850 Switching Time vs. Load Resistance

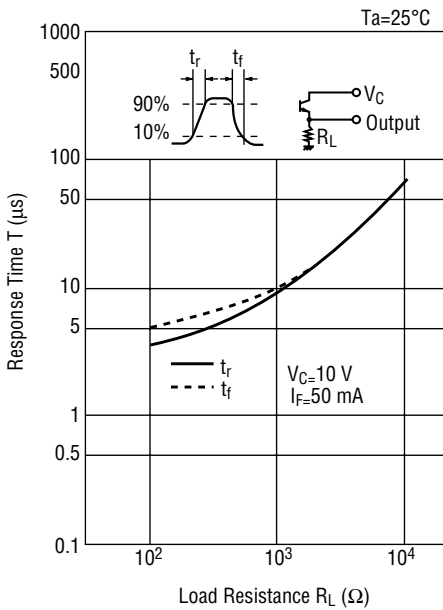

• OPU860CP—OPU852CP Switching Time vs. Load Resistance

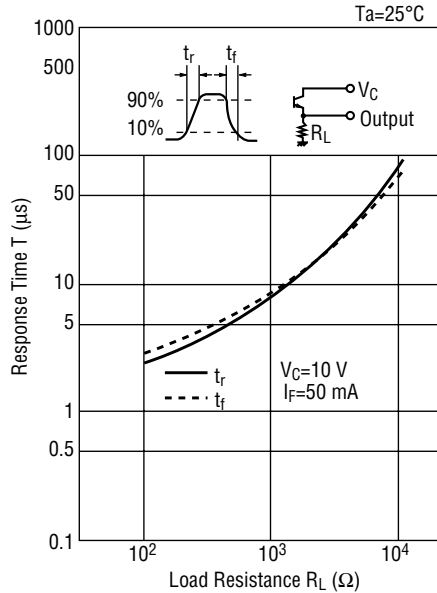

• **OPU862CP—OPU850 Switching Time vs. Load Resistance**

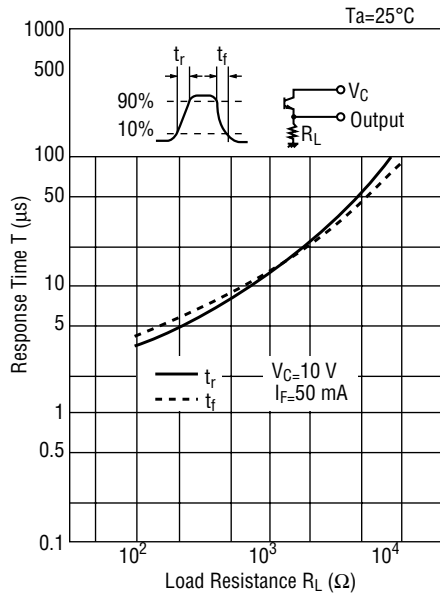

• **OPU862CP—OPU852CP Switching Time vs. Load Resistance**

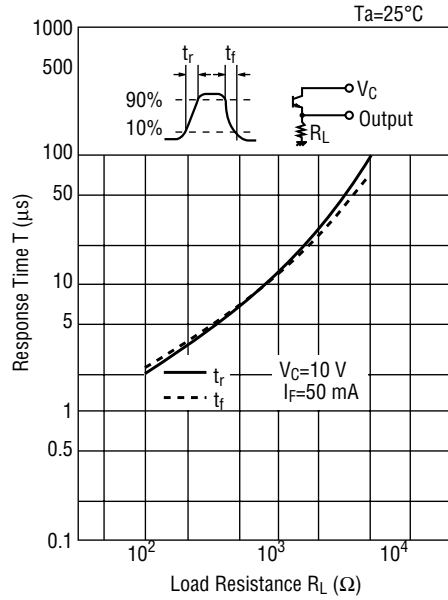

OPTION PARTS

• **Sensor Holder A Type Dimension**

(Unit: mm)

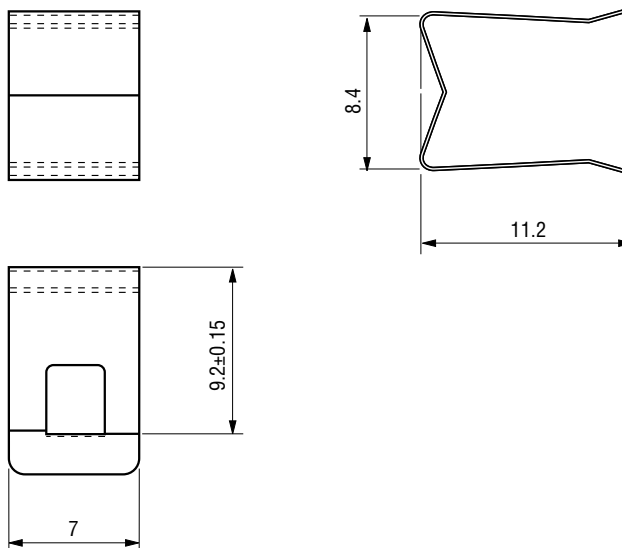

• **Sensor Holder B Type Dimension**

(Unit: mm)

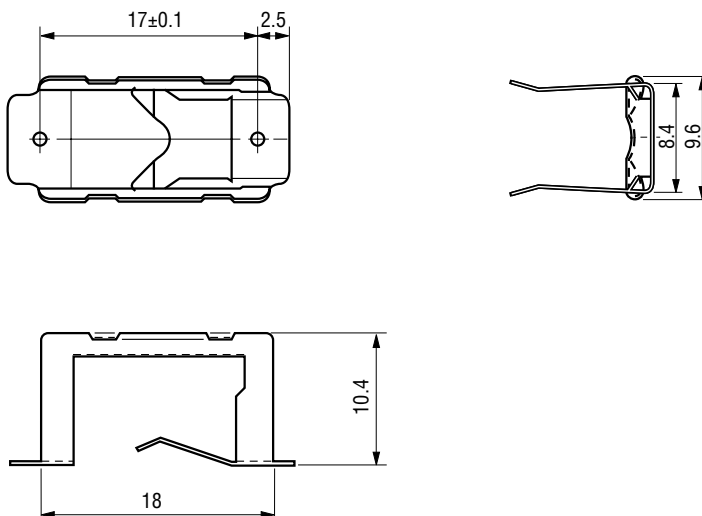

Recommended Connector for Capsule Sensor (female connector)

Product Name	Type	Maker
Connector	IL—Y—3S—S15C3	Japan Aviation Electronics Ind., Ltd.