

## GSS 系列(全球安全开关)

## 特点

- EN 50041 和 EN 50047 安装和特性
- 按 IEC 电气标准设计用于世界范围的防护
- 符合 IEC/EN 60947-5-1-3 的常闭触点的正开启操作
- 供有范围广阔的正开启触点
- 坚实的外壳(锌压铸)
- 适于安全应用的全范围的执行器头和杠杆
- 密封达 IP 67(NEMA1,4,12 和 13)
- 抓取动作和慢动作的基本开关
- 国际导管尺寸
- 电流隔绝触点
- UL 注册, CSA 和 CE 认证  
BG 批准(除非指明)
- 红色外壳易于安全识别

## 效益

- 应用中立即可识别出为安全部件
- 标准安装和特性
- 全球可得和全球可用
- 焊接的触点可以分开-安全应用中的要害
- 在防护和机器状态的应用中有范围较广的探查安全状况的促动方法
- 接线和外壳的灵活性
- 适用于感应切换和安全继电器接口
- 信号发送和电源安全电路可用不同的极性 or 电压



(申请中)



GSS 系列产品可以作为 1 类安全部件单独使用。如与其它安全开关和我们的全范围的安全继电器合用, 则能构成与 2,3 或 4 类一致的综合保护方案。

霍尼韦尔的设计经验在安全开关技术方面形成了全新的具有独创的概念。在每一个顺序点的下行行程上顺序安全开关包括有正开启。这使得用户同时具有警告信号和停止信号。有了这种信息, 一个门可以在它们停止机器之前关闭或者通过设置调整过分的运动。这样就避免了停机。

## 低能量切换

在当今需求低能量控制的年代, 机电开关常常用来直接和安全继电器, PLC 和其它低能量装置直接接口。为适应这个需求, GSS 提供一种标准基本开关的镀金触点方案, 这项措施改进了在低电流和低电压下接触的可靠性, 保护了触点在操作或使用前贮藏期间免受污染。

标准银触点的缺点是在某些特殊的环境条件下, 如有潮气, 会失去光泽。

## 低能量基本开关的额定值如下:

操作电压  $U_o$  1 至 50 Vac 或 Vdc  
操作电流  $I_o$  1 microamp 至 100 mA

使用低能量基本开关 GSAB 07A1B 的样本列表举例

## 警告

## 文件的误用

- 此产品单(或目录)中提供的资料信息仅供参考之用。切勿将此文件作为系统安装的资料使用
- 完整的安装、运行和维修资料提供在随每个产品一起交付的说明书中。不遵循这些指导可能引起死亡或重伤。

**GSA EN 50041**

安全金属  
标准

技术数据

机械 达一千万次动作

寿命

保护 IP 67

程度 NEMA/UL

类型 1, 4, 12, 13

温度 操作:

范围 -25 至+85°C

-13 至+185°F

存放:

-40 至+85°C

-40 至+185°F

认可\*

IEC 60947-5-1

EN 60947-5-1

AC15 A300/A600

DC13 Q300

UL & CSA

振动 10g, 符合 IEC 68-2-26 标准

冲击 50g, 符合 IEC 68-2-26 标准

终端标识于 EN 50013 上

\*参阅标准 (161 页)

GSS

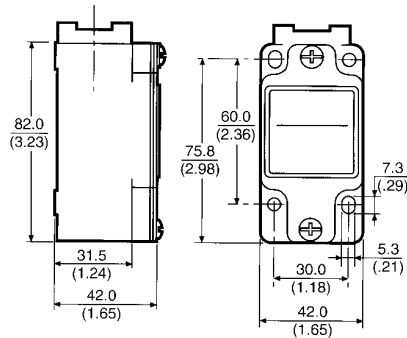

导管螺纹

- A** = 1/2" NPT
- B** = PG 13.5
- C** = 20 mm
- D** = PF 1/2"

▲低能触头

注: 见 179 页

订货号:

示例: GSA B 01 B

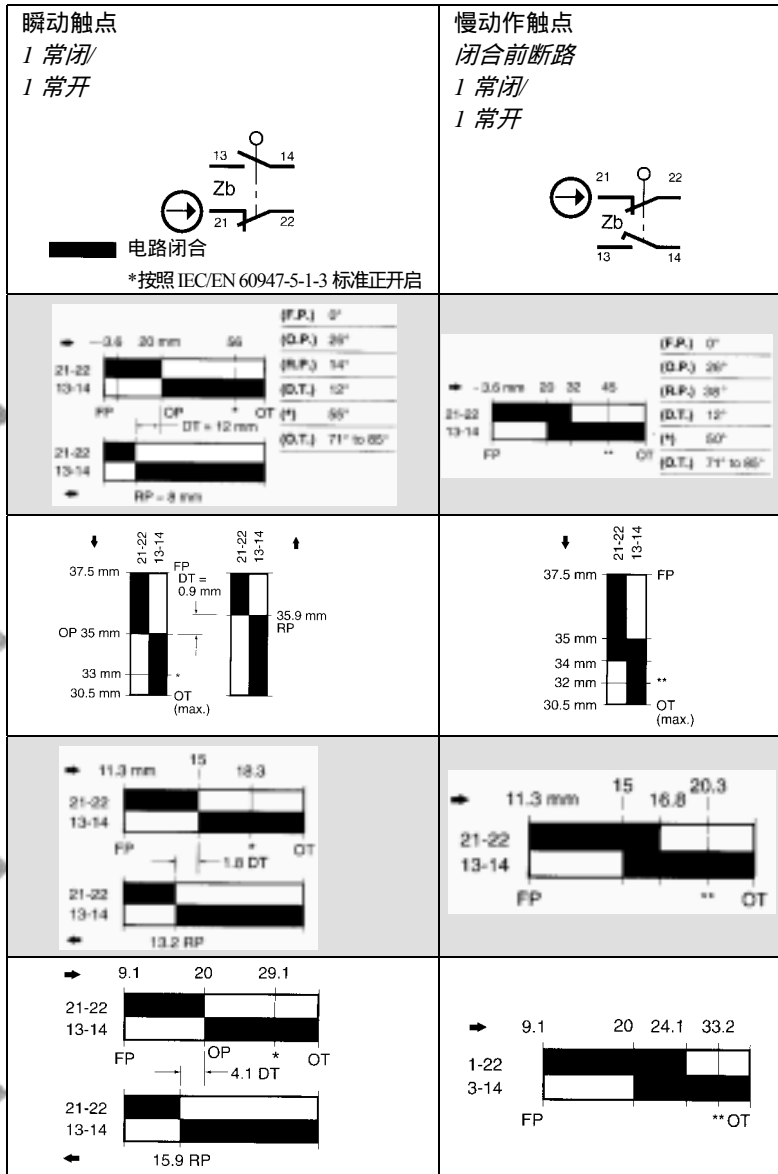

\*确保正开启的起始点

\*\*正开启始于运行位置, 但为了达到 IEC/EN 60947-5-3 所要求的 2.5kV 电介间隙, 就必须在\*处确保正开启。

| 慢动作触点<br>2 常闭 | 瞬动触点<br>双孔<br>2 常闭/<br>2 常开 | 瞬动触点<br>双孔<br>2 常闭/<br>2 按顺序常开 | 促动器类型            |
|---------------|-----------------------------|--------------------------------|------------------|
|               |                             |                                | <p>边旋转式，金属滚轮</p> |
|               |                             |                                | <p>顶部针式柱塞</p>    |
|               |                             |                                | <p>顶部辊式柱塞</p>    |
|               |                             |                                | <p>顶部辊式杠杆</p>    |

GSS

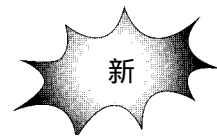

参见下一页了解附加开关类型

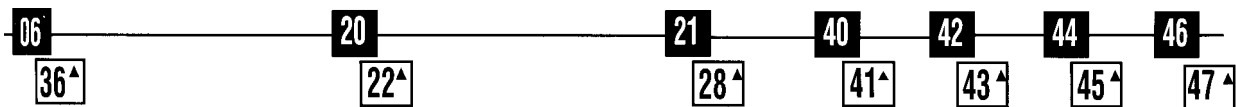

**XXX**

|   |  |  |  |
|---|--|--|--|
| <p>慢动作触点<br/>4 常闭</p>   | <p>慢动作触点<br/>2 常闭<br/>1 常开<br/>闭合前断路</p>   | <p>慢动作触点<br/>2 常闭<br/>2 常开<br/>闭合前断路</p>   |  |
| <p>(F.P.) 0° (D.T.)<br/>(O.P.) 20° (I) 30°<br/>(R.P.) (D.T.) 71° to 85°</p> | <p>(F.P.) 0° (R.P.)<br/>(O.P.1) 20° (D.T.)<br/>(O.P.2) 32° (I) 30°<br/>(D.T.) 71° to 85°</p> | <p>(F.P.) 0° (R.P.)<br/>(O.P.1) 26° (D.T.)<br/>(O.P.2) 32° (I) 38°<br/>(D.T.) 71° to 85°</p> |  |
| <p>37.5 mm<br/>35 mm<br/>33 mm<br/>30.5 mm<br/>OT (MAX)</p>                 | <p>37.5 mm<br/>35 mm<br/>34 mm<br/>33 mm<br/>30.5 mm<br/>OT (MAX)</p>                        | <p>37.5 mm<br/>35 mm<br/>34 mm<br/>33 mm<br/>30.5 mm<br/>OT (MAX)</p>                        |  |
| <p>11.3 15 18.3<br/>OT</p>  | <p>11.3 15 18.3<br/>16.8<br/>OT</p>  | <p>11.3 15 18.3<br/>16.8<br/>OT</p>  |  |
| <p>9.1 20 29.1<br/>OT</p>   | <p>9.1 20 29.1<br/>24.1<br/>OT</p>   | <p>9.1 20 29.1<br/>24.1<br/>OT</p>   |  |

GSS

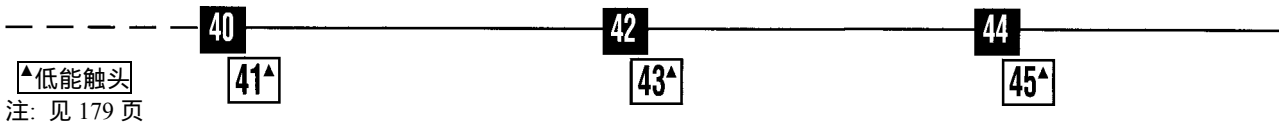

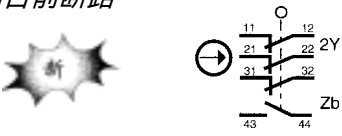
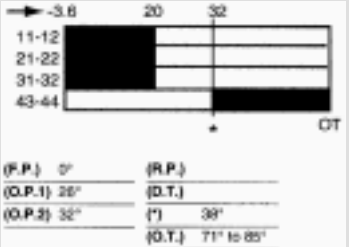
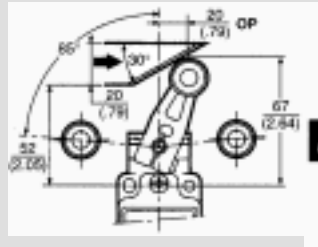
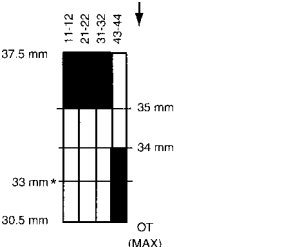
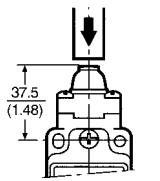
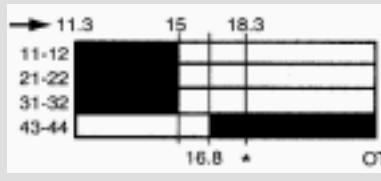
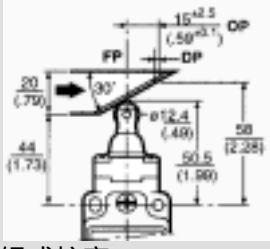
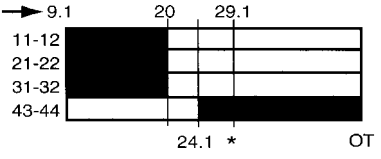
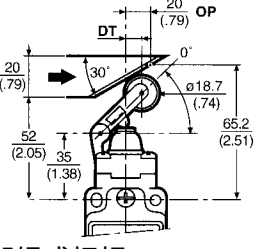
|  |   |  |
|--|---|--|
|  | <p><b>慢动作触点</b><br/>                 3 常闭/<br/>                 1 常开<br/>                 闭合前断路</p>  | <p><b>促动器类型</b></p>  |
|  |    |  <p style="text-align: right;"><b>A1B</b></p>                      |
|  |    |  <p><b>顶部针式柱塞</b></p> <p style="text-align: right;"><b>B</b></p>   |
|  |    |  <p><b>顶部辊式柱塞</b></p> <p style="text-align: right;"><b>C</b></p> |
|  |    |  <p><b>顶部辊式杠杆</b></p> <p style="text-align: right;"><b>D</b></p> |

GSS

46  
47

**XXX**

**GSC EN 50047**  
安全金属标准

技术数据

机械 达一千万次动作

寿命

保护 IP 66

程度 NEMA/UL

类型 1, 4, 12, 13

温度 操作:

范围 -25°C 至+85°C

-13°F 至+185°F

存放:

-40°C 至+85°C

-40°F 至+185°F

认可\* IEC 60947-5-1

EN 60947-5-1

AC15 A300

DC13 Q300

BG, UL & CSA

振动 10g, 符合 IEC 68-2-6

冲击 50g, 符合 IEC 68-2-27 标准

终端标识于 EN 50013

\*参阅标准(161 页)

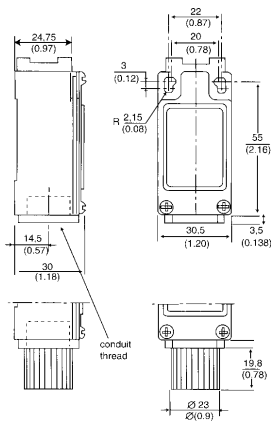

导管螺纹

**A** = 1/2" NPT

**B** = PG 13.5

**C** = 20 mm

**D** = PF 1/2" ▲低能量触点  
注: 见 179 页

注: 插入式安全螺钉

订货号:

**GSC**

**X**

示例: GSC B 01 B

|                                |   |
|--------------------------------|---|
| <p>瞬动触点<br/>1 常闭/<br/>1 常开</p> | <p>慢动作触点<br/>闭合前断路<br/>1 常闭/<br/>1 常开</p> |
|                                |   |
|                                |   |
|                                |   |
|                                |   |

\*确保正开启的起始点

\*\*正开启始于运行位置, 但为了达到 IEC/EN 60947-5-3 所要求的 2.5kV 的电介间隙, 就必须在\*处确保正开启。

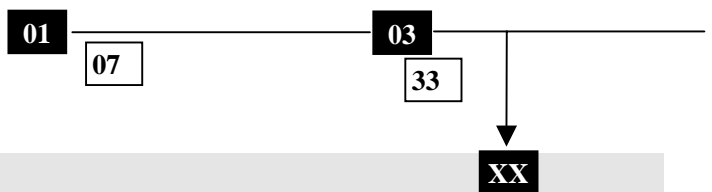

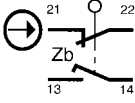
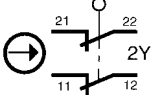
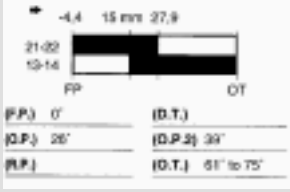
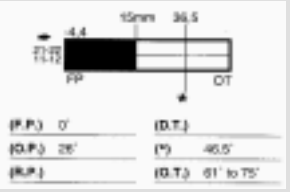
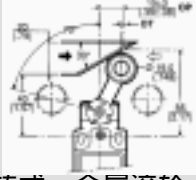
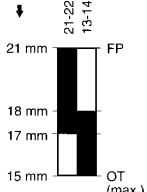
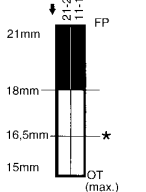
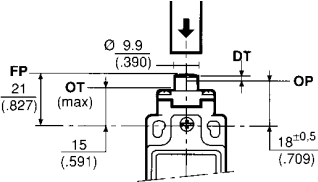
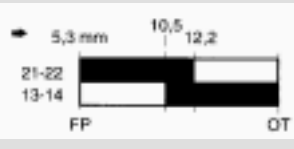
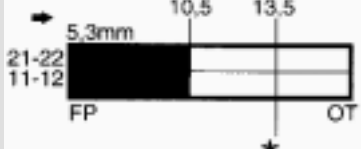
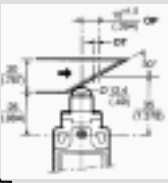
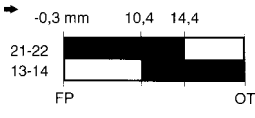
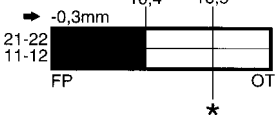
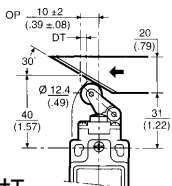
|   |   |   |
|---|---|---|
| <p>慢动作触点<br/>闭合前断路<br/>1 常闭/<br/>1 常开</p>                                        | <p>慢动作触点<br/>2 常闭</p>    | <p>执行器类型</p>  |
|  <p>(P.P.) 0° (D.T.)<br/>(O.P.) 25° (D.P.2) 33°<br/>(R.P.) (D.T.) 51° to 75°</p> |  <p>(P.P.) 0° (D.T.)<br/>(O.P.) 25° (°) 46.5°<br/>(R.P.) (D.T.) 51° to 75°</p> |  <p><b>侧面旋转式，金属滚轮</b></p> <p><b>A1B</b><br/>可提供<br/>附加杠杆<br/>(见 190 页)</p> |
|    |    |  <p><b>顶部针式柱塞</b></p> <p><b>B</b></p>                                       |
|   |   |  <p><b>顶部辊式柱塞</b></p> <p><b>C</b></p>                                     |
|    |    |  <p><b>顶部辊式杠杆</b></p> <p><b>D</b></p>                                    |

GSS

04

34^

06

36^

XXX

**GSD EN 50047**  
安全双绝缘标准

技术数据

机械 达一千万次动作

寿命

保护 IP 66

程度 NEMA/UL

类型 1, 12, 13

温度 操作:

范围 -25°C 至+85°C

-13°F 至+185°F

存放:

-40°C 至+85°C

-40°F 至+185°F

认可\* IEC 60947-5-1

EN 60947-5-1

AC15 A600

DC13 Q300

BG, UL & CSA

振动 10g, 符合 IEC 68-2-6

冲击 50g, 符合 IEC 68-2-27 标准

终端标识于 EN 50013

\*参阅标准(161 页)

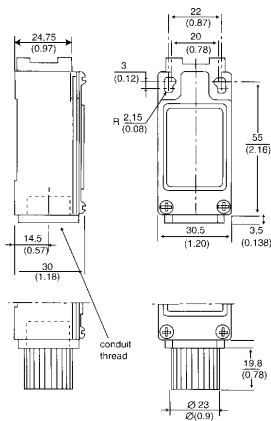

导管螺纹

**A** = 1/2" NPT

**B** = PG 13.5

**C** = 20 mm

**D** = PF 1/2" ▲低能量触点  
注: 见 179 页

注: 插入式安全螺钉

订货号:

**GSD**

**X**

示例: GSD B 01 B

|                                |   |
|--------------------------------|---|
| <p>瞬动触点<br/>1 常闭/<br/>1 常开</p> | <p>慢动作触点<br/>闭合前断路<br/>1 常闭/<br/>1 常开</p> |
|                                |   |
|                                |   |
|                                |   |
|                                |   |

\*确保正开启的起始点

\*\*正开启始于运行位置, 但为了达到 IEC/EN 60947-5-3 所要求的 2.5kV 的电介间隙, 就必须在\*处确保正开启。

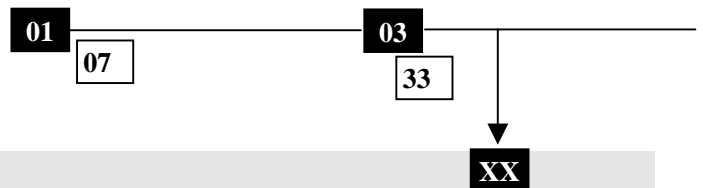

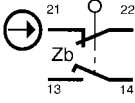
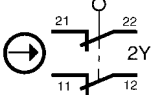
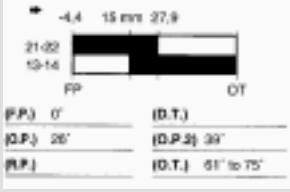
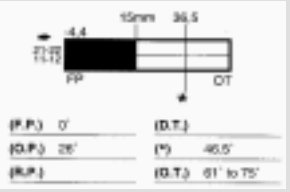
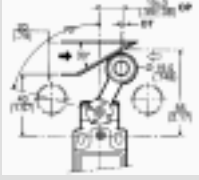
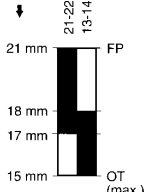
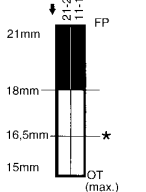
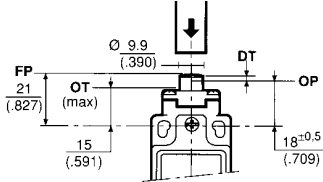
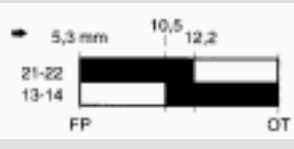
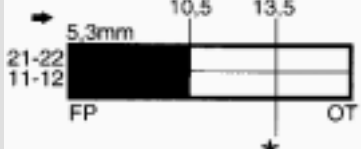
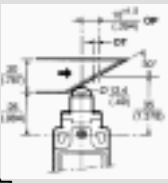
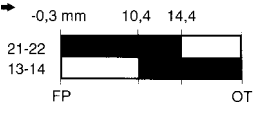
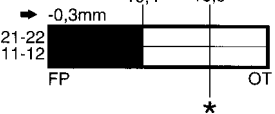
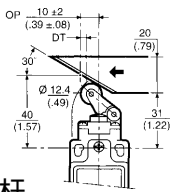

|   |   |  |
|---|---|--|
| <p>慢动作触点<br/>闭合前断路<br/>1 常闭/<br/>1 常开</p>                                        | <p>慢动作触点<br/>2 常闭</p>    | <p>执行器类型</p>   |
|  <p>(P.P.) 0° (D.T.)<br/>(O.P.) 25° (D.P.2) 33°<br/>(R.P.) (D.T.) 51° to 75°</p> |  <p>(P.P.) 0° (D.T.)<br/>(O.P.) 25° (°) 46.5°<br/>(R.P.) (D.T.) 51° to 75°</p> |  <p><b>A1B</b><br/>可提供<br/>附加杠杆<br/>(见 190 页)</p> |
|    |    |  <p><b>B</b><br/>顶部针式柱塞</p>                        |
|   |   |  <p><b>C</b><br/>顶部辊式柱塞</p>                      |
|    |    |  <p><b>D</b><br/>顶部辊式杠杆</p>                     |

GSS

04

34^

06

36^

XXX

**GSE EN 50047 兼容  
安全 3 导管金属标准**

技术数据

机械 达一千万次动作

寿命

保护 IP 66

程度 NEMA/UL

类型 1, 4, 12, 13

温度 操作:

范围 -25°C 至+85°C

-13°F 至+185°F

存放:

-40°C 至+85°C

-40°F 至+185°F

认可\* IEC 60947-5-1

EN 60947-5-1

AC15 A300

DC13 Q300

BG, UL & CSA

振动 10g, 符合 IEC 68-2-6

冲击 50g, 符合 IEC 68-2-27 标准

终端标识于 EN 50013

\*参阅标准(161 页)

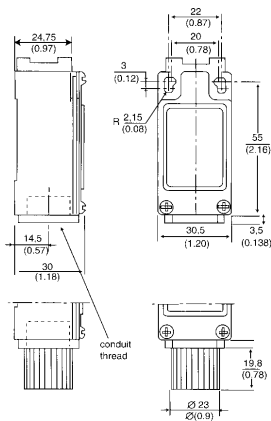

导管螺纹

**A** = 1/2" NPT

**B** = PG 13.5

**C** = 20 mm

**D** = PF 1/2" ▲低能量触点  
注: 见 179 页

注: 插入式安全螺钉

订购:

**GSE**

**X**

示例: GSE B 01 B

|                                |   |
|--------------------------------|---|
| <p>瞬动触点<br/>1 常闭/<br/>1 常开</p> | <p>慢动作触点<br/>闭合前断路<br/>1 常闭/<br/>1 常开</p> |
|                                |   |
|                                |   |
|                                |   |
|                                |   |

\*确保正开启的起始点

\*\*正开启始于运行位置, 但为了达到 IEC/EN 60947-5-3 所要求的 2.5kV 的电介间隙, 就必须在\*处确保正开启。

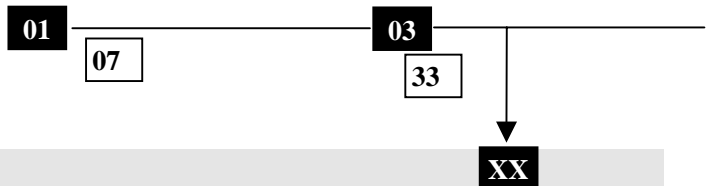

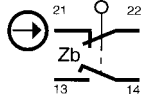
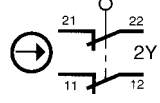
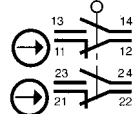
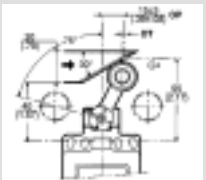
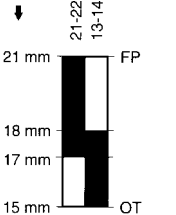
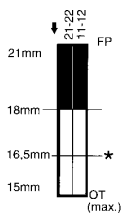
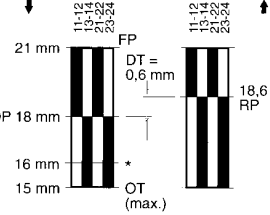
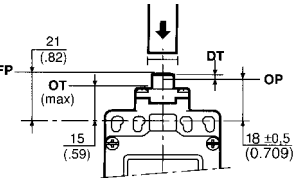
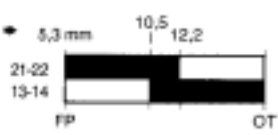
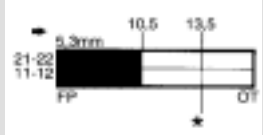
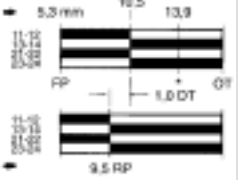
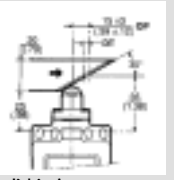
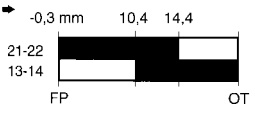
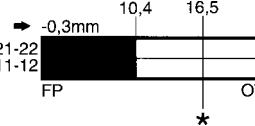
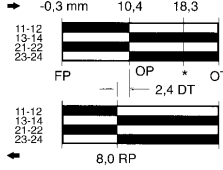
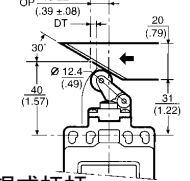
| 慢动作触点<br>闭合前断路<br>1 常闭<br>1 常开   | 瞬动触点<br>双孔<br>2 常闭/<br>2 常开   | 瞬动触点<br>双孔<br>2 常闭/<br>2 常开   | 执行器类型   |
|--|---|---|---|
|  <p>FP OT</p> <p>(F.P.) 0' (O.T.)</p> <p>(O.P.) 26' (O.P.2) 36'</p> <p>(R.P.) (O.T.) 61' to 75'</p> |  <p>FP OT</p> <p>(F.P.) 8' (O.T.)</p> <p>(O.P.) 25' (O.T.) 48.5'</p> <p>(R.P.) (O.T.) 61' to 75'</p> |  <p>FP OT</p> <p>(F.P.) 0' (O.T.)</p> <p>(O.P.) 26' (O.T.) 48.5'</p> <p>(R.P.) 180' (O.T.) 61' to 75'</p>    |  <p><b>A18</b></p> <p>可提供附加杠杆 (见 190 页)</p> <p>侧面旋转式, 金属滚轮</p>   |
|  <p>21 mm FP</p> <p>18 mm</p> <p>17 mm</p> <p>15 mm OT</p>  |  <p>21 mm FP</p> <p>18 mm</p> <p>16.5 mm *</p> <p>15 mm OT (max.)</p>                                |  <p>21 mm FP</p> <p>18 mm OP</p> <p>16 mm *</p> <p>15 mm OT (max.)</p> <p>DT = 0.6 mm</p> <p>18.6 mm RP</p> |  <p>21 (82)</p> <p>FP OT (max)</p> <p>DT</p> <p>OP</p> <p>15 (59)</p> <p>18 ±0.5 (0.709)</p> <p><b>B</b></p>                                     |
|  <p>FP OT</p> <p>(F.P.) 5.3 mm (O.T.)</p> <p>(O.P.) 10.5 (O.P.2) 12.2</p>                          |  <p>FP OT</p> <p>(F.P.) 5.3 mm (O.T.)</p> <p>(O.P.) 10.5 (O.T.) 13.5</p>                            |  <p>FP OT</p> <p>(F.P.) 5.3 mm (O.T.)</p> <p>(O.P.) 10.5 (O.T.) 13.3</p> <p>1.0 DT</p> <p>9.5 RP</p>       |  <p>顶部辊式柱塞</p> <p><b>C</b></p>  |
|  <p>FP OT</p> <p>(F.P.) -0.3 mm (O.T.)</p> <p>(O.P.) 10.4 (O.P.2) 14.4</p>                        |  <p>FP OT</p> <p>(F.P.) -0.3 mm (O.T.)</p> <p>(O.P.) 10.4 (O.T.) 16.5 *</p>                        |  <p>FP OT</p> <p>(F.P.) -0.3 mm (O.T.)</p> <p>(O.P.) 10.4 (O.T.) 18.3</p> <p>2.4 DT</p> <p>8.0 RP</p>     |  <p>OP -10 ±2 (39 ±08)</p> <p>OT</p> <p>20 (79)</p> <p>30°</p> <p>∅12.4 (49)</p> <p>40 (157)</p> <p>31 (122)</p> <p>顶部辊式杠杆</p> <p><b>D</b></p> |

GSS

**04**  
**34^**

**06**  
**36^**

**24**  
**32^**

**XXX**

附加的杠杆类型

用在所有侧面旋转头类型

图 1 表示符合 EN 50041 的标准杠杆型

所有尺寸的单位是 mm/(in)。

GSS

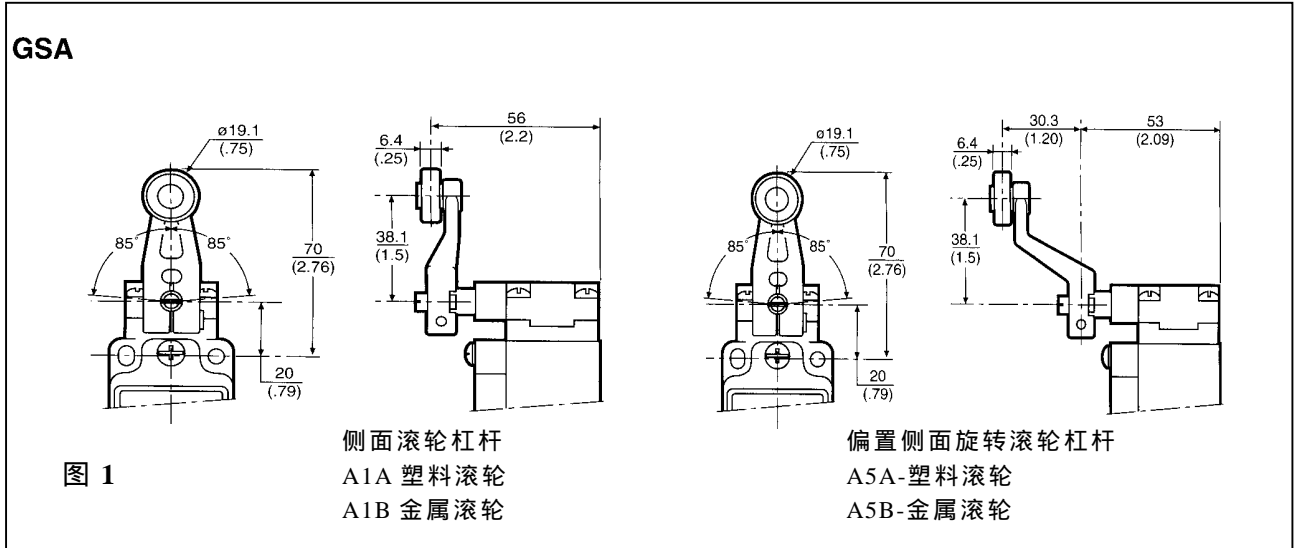

图 2 表示符合 EN 50047 的标准杠杆型

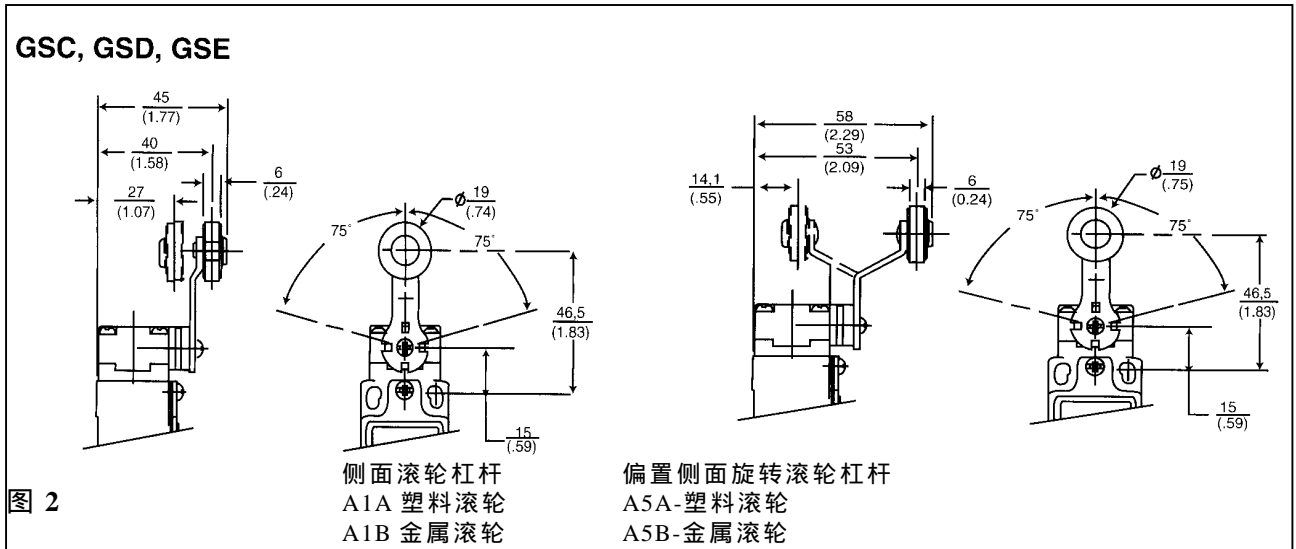

注：当安装所有侧面旋转型杠杆时，要特别注意保证在力的作用下设定的杠杆位置不会改变。为了达到杠杆确实保持在位，杠杆应按图所示或以 90°增量安装，并且必须装入轴上的方形端安全装实。