

Infrared Spiral Wound Radiation Source JSIR450

Powerful radiation source with circular homogeneous temperature distribution for use with thermopiles and pyroelectric detectors in NDIR gas analysis and other applications.

Spectral Output Range ¹	typ. 0.8 ... 15	µm
Active Area	2.2 dia	mm ²
Hot Resistant	12±1	Ω
Time Constant	typ. 530	ms
Nominal Power Consumption	0.7	W
Operation Voltage ²	typ. 2.9	V
Operation Current ²	typ. 242	mA
Active Area Temperature ^{3,4}	650	°C
Filling Gas	-	
Filter	-	
Mass	~1	g
Housing	T039 (modified)	
Lifetime	> 50,000 h at 650 °C	

¹ without window

² with 12Ω

³ at nominal power (0.7W)

⁴ at T_{amb} = 25 °C

The current data are based on simulations and tests. They are subject to change during the next evaluation steps.

September 27th 2012 - subject to change without notice

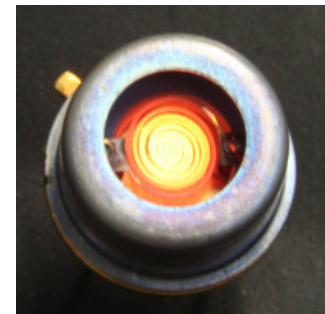

Pin Assignment

Bottom View

Pin 1 Power
Pin 2 Power

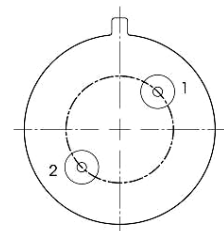

Absolute Max. Ratings

Power	1.7	W
Housing temperature	200	°C

Ordering Information

JSIR450

6350.01-3.01

Micro-Hybrid Electronic GmbH

Heinrich-Hertz-Straße 8
D-07629 Hermsdorf

Tel.: +49 366 01 592 100
Fax: +49 366 01 592 110

Email: Infrared@micro-hybrid.de
Web: www.micro-hybrid.de

LIVING MICROWORLDS.

Infrared Spiral Wound Radiation Source JSIR450

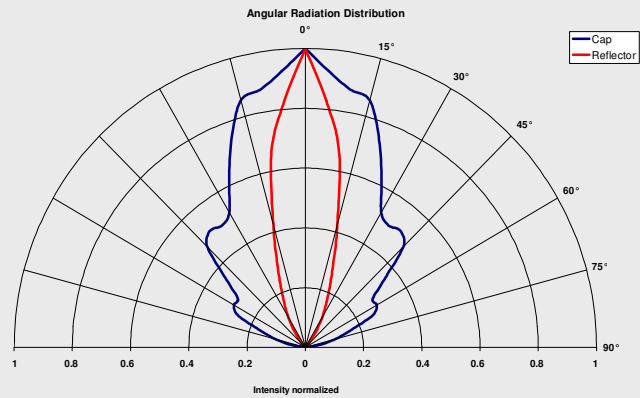
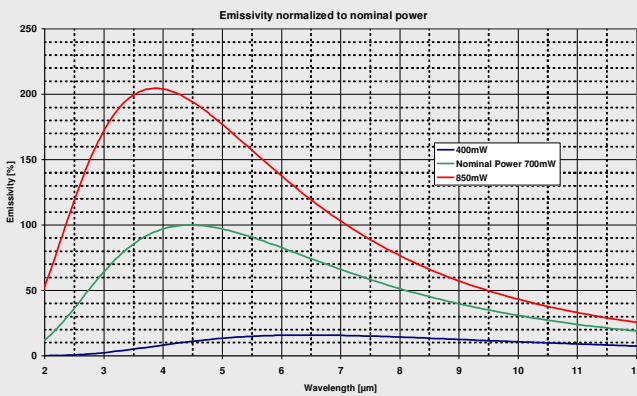
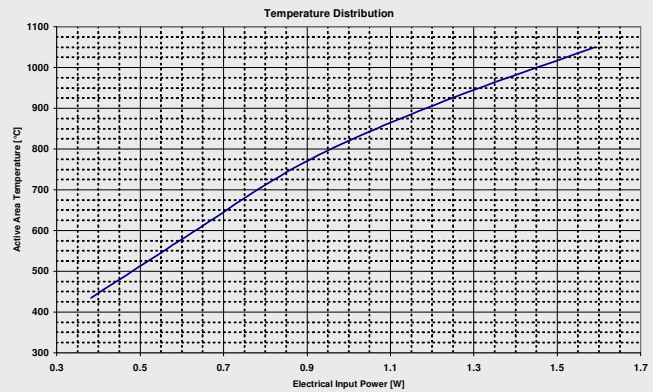
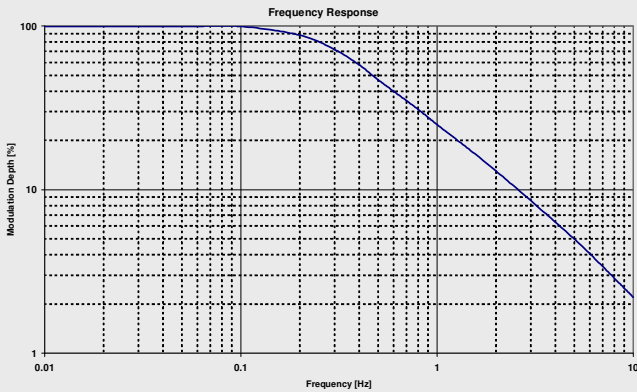

Housing

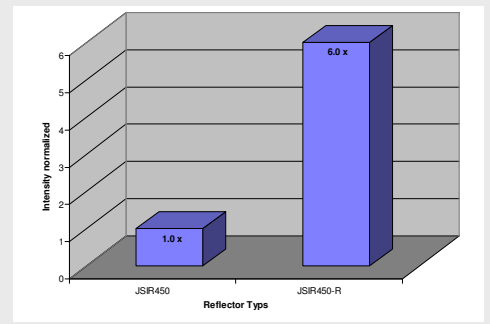
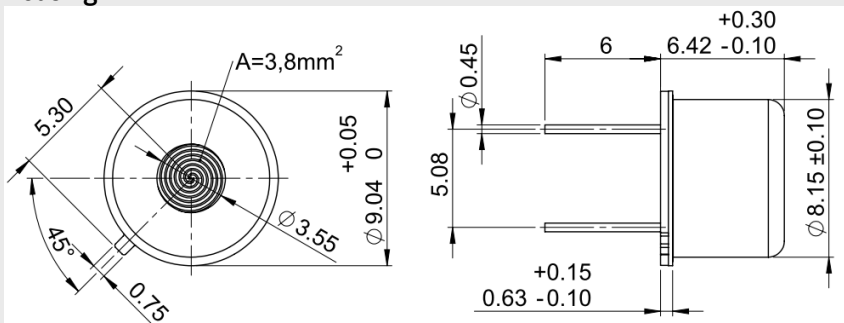

Optional parts

IR-Detector PS2x4V1- Pyroelectric dual-channel voltage mode detector CO₂/Ref
Art.-Nr. 4594.56-H.02

Evaluation Kit - For independent evaluation of emitters and detectors
Art.-Nr. 7206.01-A.00

Micro-Hybrid Electronic GmbH

**Heinrich-Hertz-Straße 8
D-07629 Hermsdorf**

**Tel.: +49 366 01 592 100
Fax: +49 366 01 592 110**

**Email: Infrared@micro-hybrid.de
Web: www.micro-hybrid.de**

LIVING MICROWORLDS.

September 27th 2012 - subject to change without notice